

Master Wrestling 2014.EndRound3.EndRound7

GISA

[Printable brackets](#)

Jump to [Team scores](#)

Jump to bracket:			
106 lbs	113 lbs	120 lbs	126 lbs
132 lbs	138 lbs	145 lbs	152 lbs
160 lbs	170 lbs	182 lbs	195 lbs
220 lbs	285 lbs		

Team scores [\(back to top\)](#)

Team name	Score	Placers	Wins	Losses	P Falls	T Falls	M Decs
Westfield (WHS)	237.5	13	42	19	21	3	1
Bulloch Academy (BA)	232.0	11	41	16	32	2	0
Southland Academy (SAR)	154.0	7	28	20	19	0	2
Tattnall Square Academy (TSA)	151.0	9	30	20	22	0	1
Tifarea Academy (TA)	133.0	7	23	11	15	0	1
Mt. DeSales Academy (MDS)	97.0	8	22	26	17	0	1
Robert Toombs Christian Academy (RTCA)	74.0	4	15	15	11	0	1
Valwood School (VAL)	73.5	4	15	8	11	1	0
Deerfield Windsor School (DWS)	73.0	4	17	13	13	0	0
Piedmont Academy (PAC)	71.0	4	13	10	9	0	1
Weber School (WEB)	66.0	3	11	9	5	0	0
Trinity Christian School (TCS)	39.0	2	8	11	6	0	0
Unity Christian School (UCS)	35.0	2	6	4	5	0	0
Loganville Christian Academy (LCA)	31.5	1	5	8	3	1	0
John Milledge Academy (JMA)	29.0	2	7	14	6	0	0
Brandon Hall (BH)	22.0	1	6	10	5	0	0
Crisp Academy (CA)	19.0	1	4	3	2	0	1
Creekside Christian Academy (CCA)	9.0	0	3	8	3	0	0
Stratford Academy (SAE)	7.0	0	2	6	2	0	0
Mill Springs Academy (MS)	3.0	1	0	13	0	0	0
Westwood School (WW)	3.0	0	1	4	1	0	0
Sherwood Christian Academy (SCA)	0.0	0	0	0	0	0	0
Windsor Academy (WAK)	0.0	0	0	6	0	0	0

106 lbs [\(back to top\)](#)

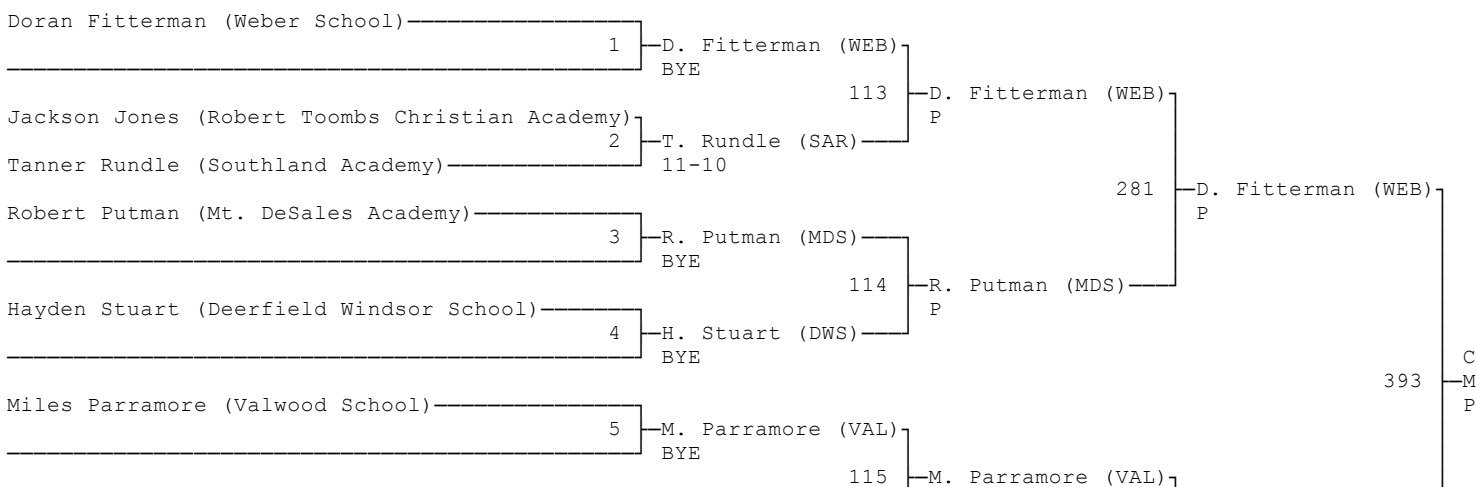

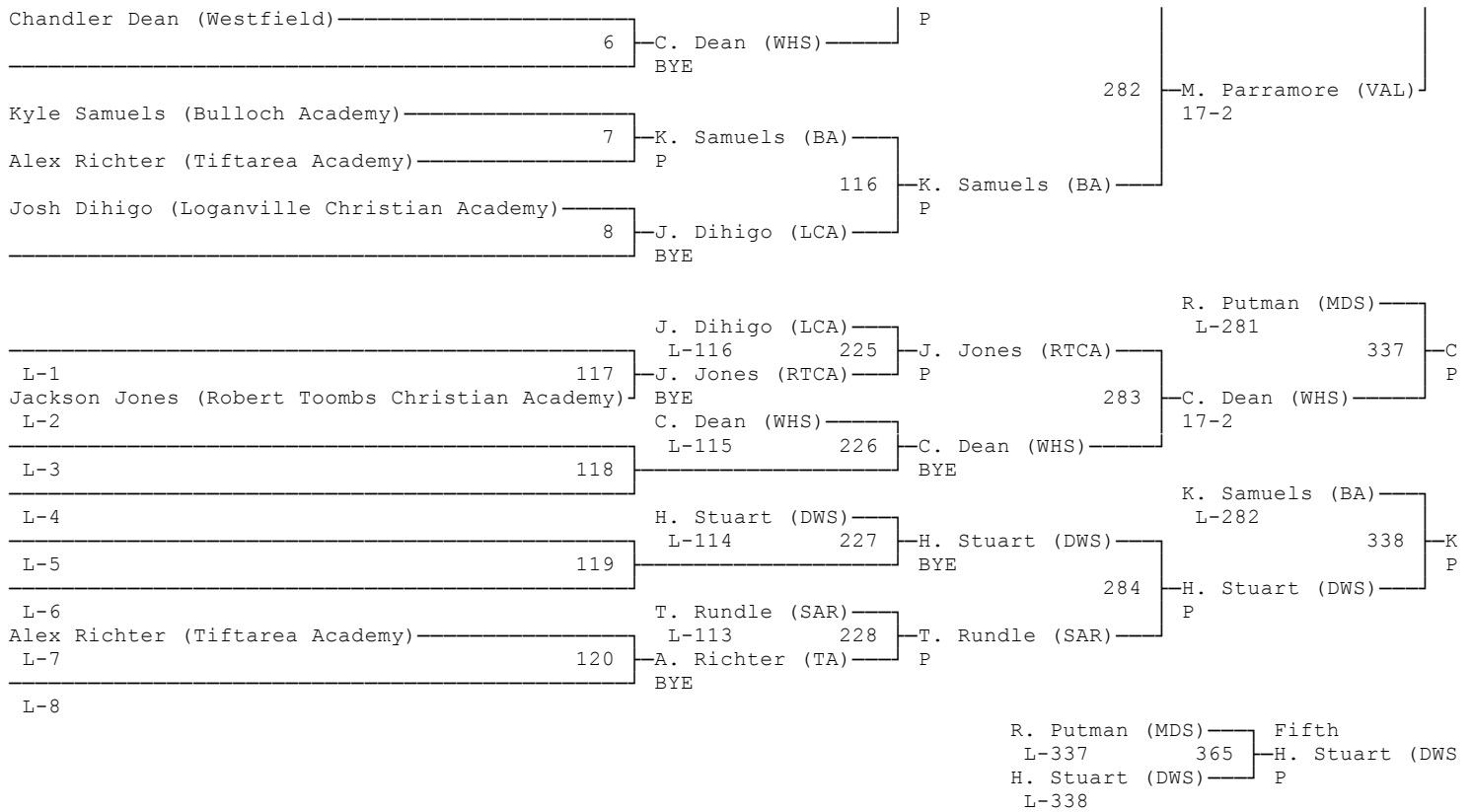

113 lbs [\(back to top\)](#)

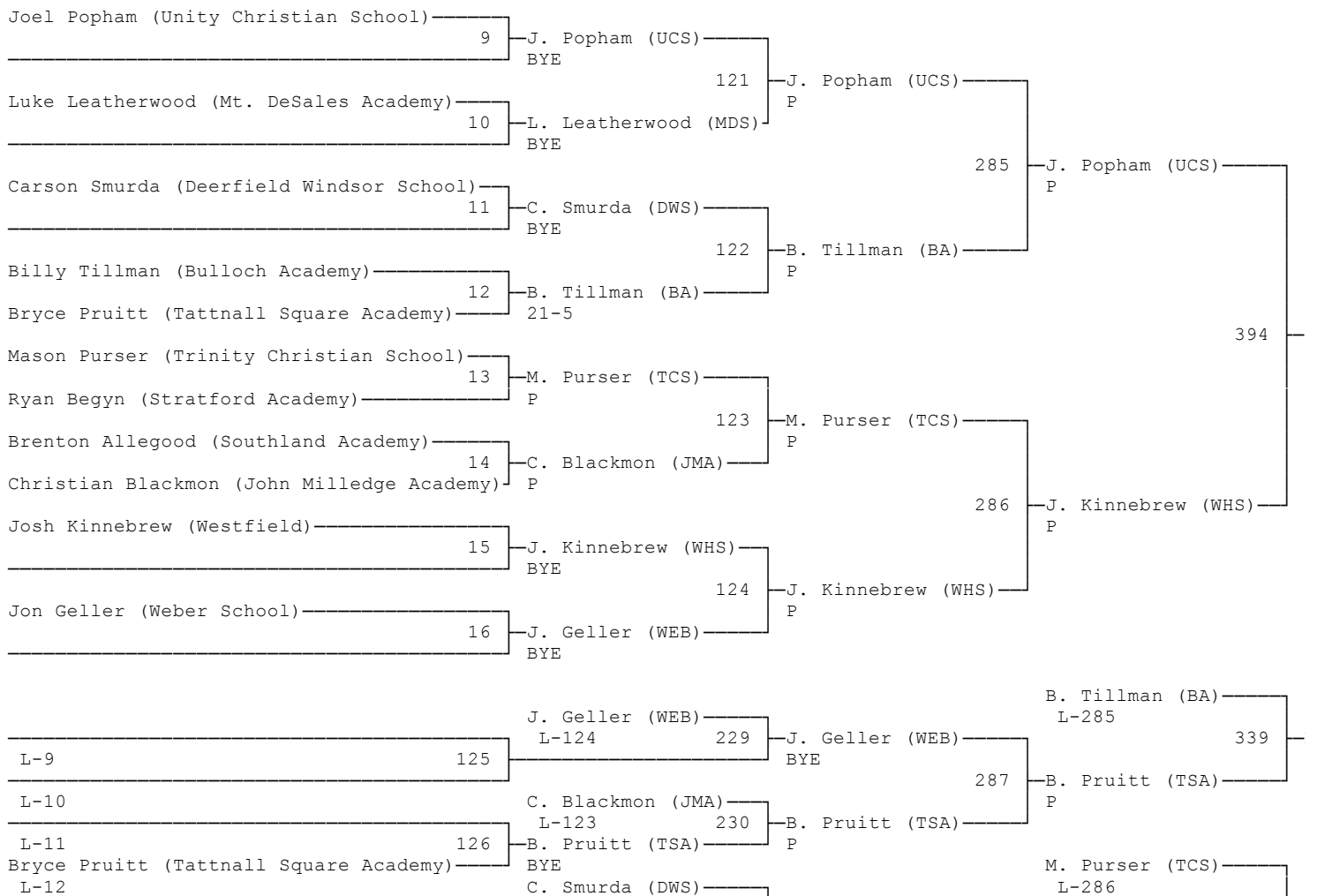

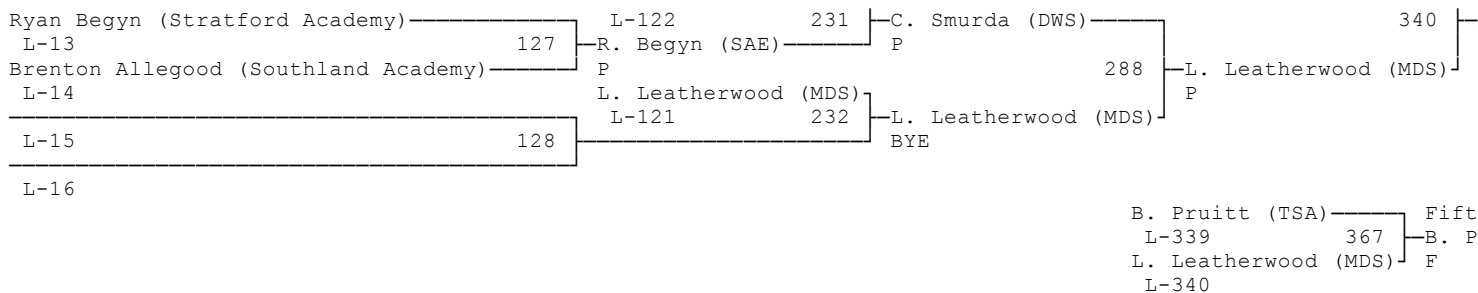

120 lbs (back to top)

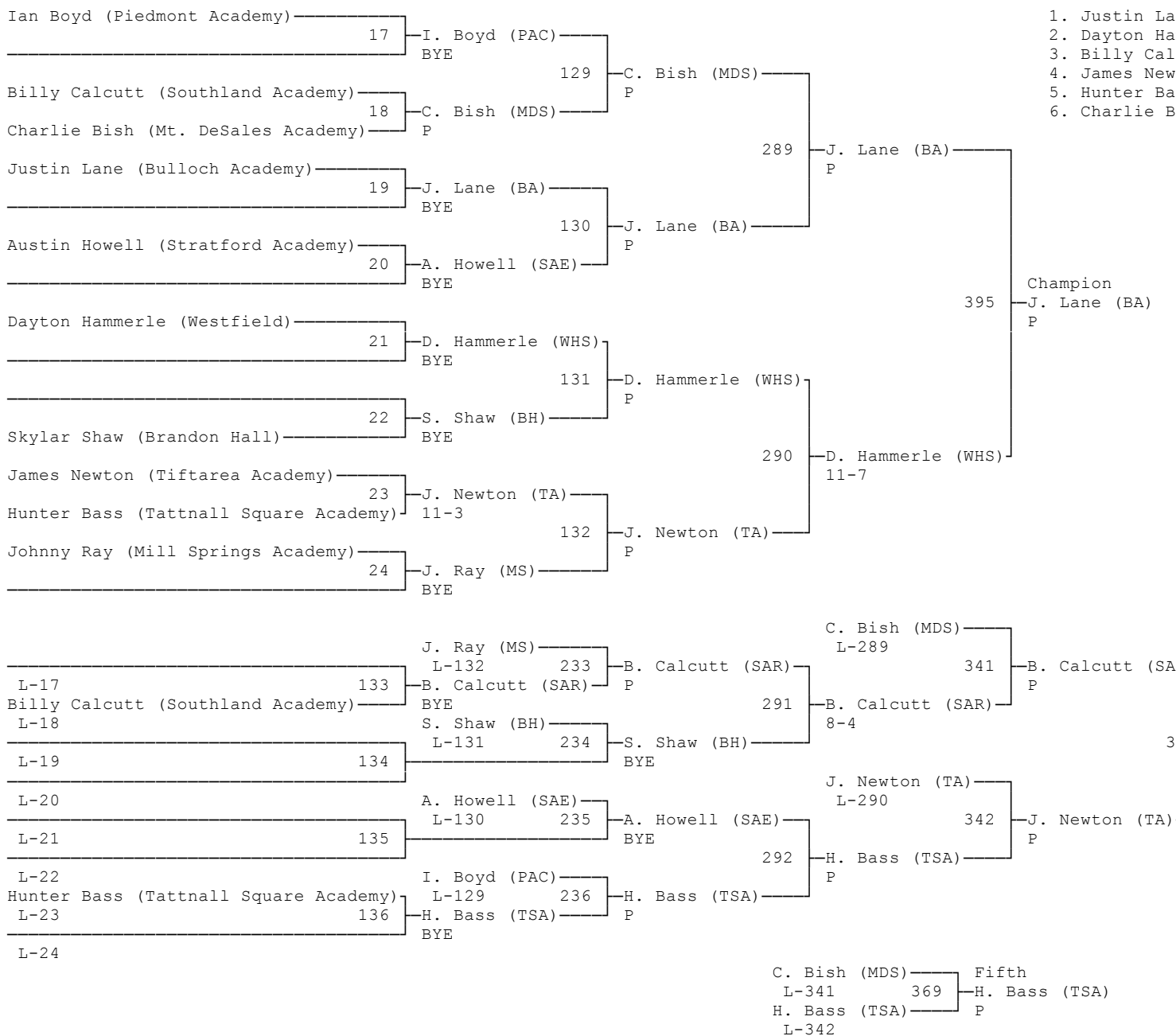

126 lbs (back to top)

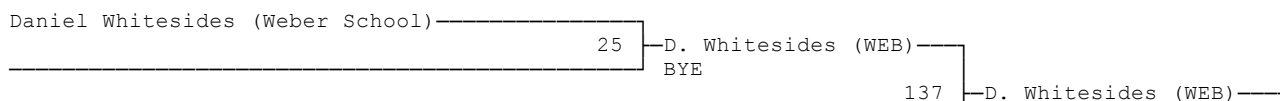

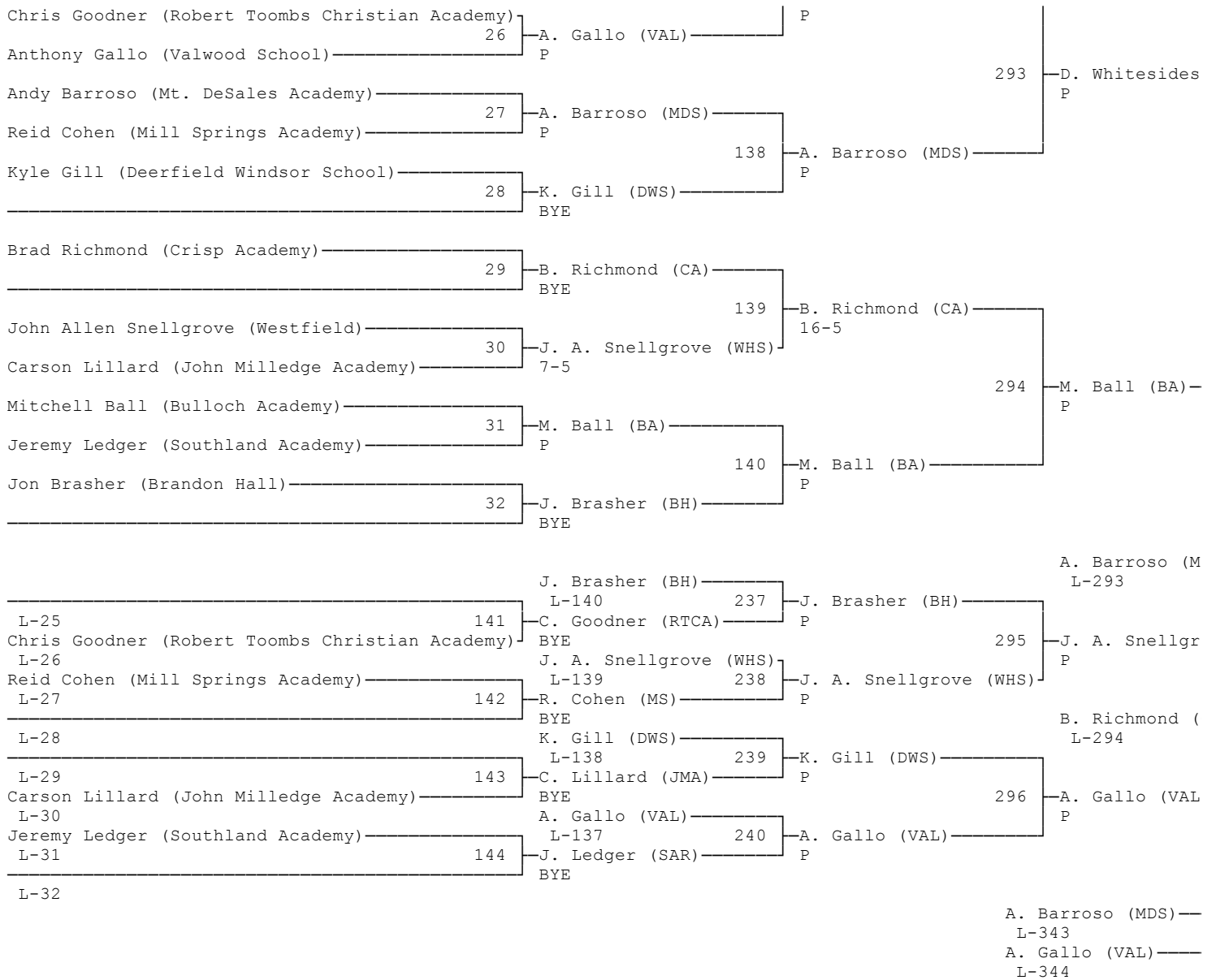

132 lbs [\(back to top\)](#)

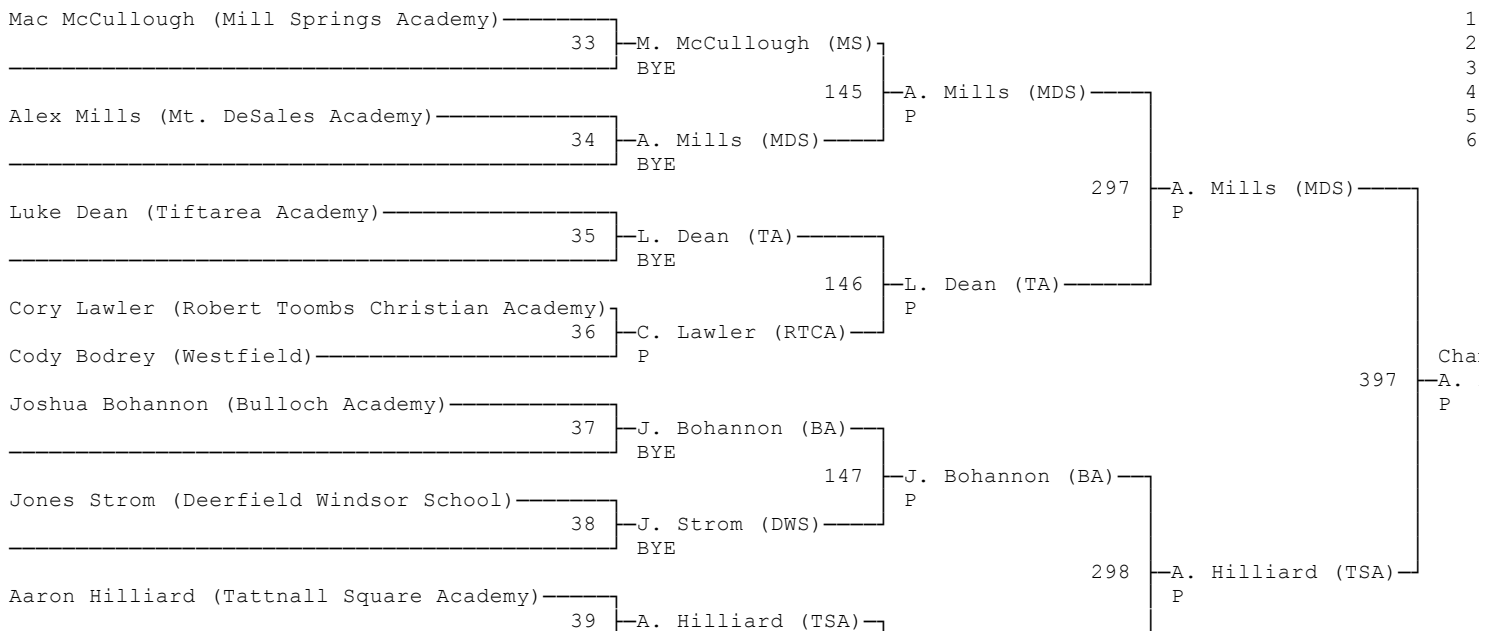

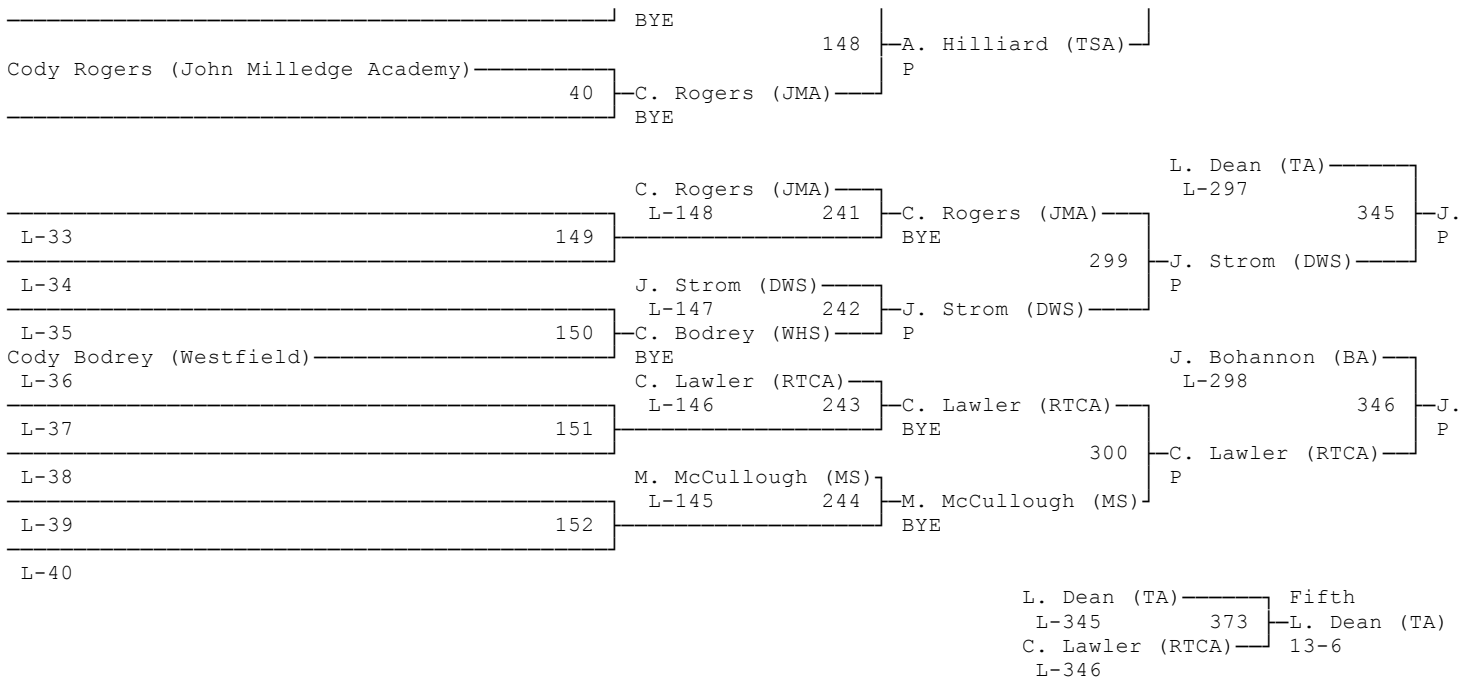

138 lbs [\(back to top\)](#)

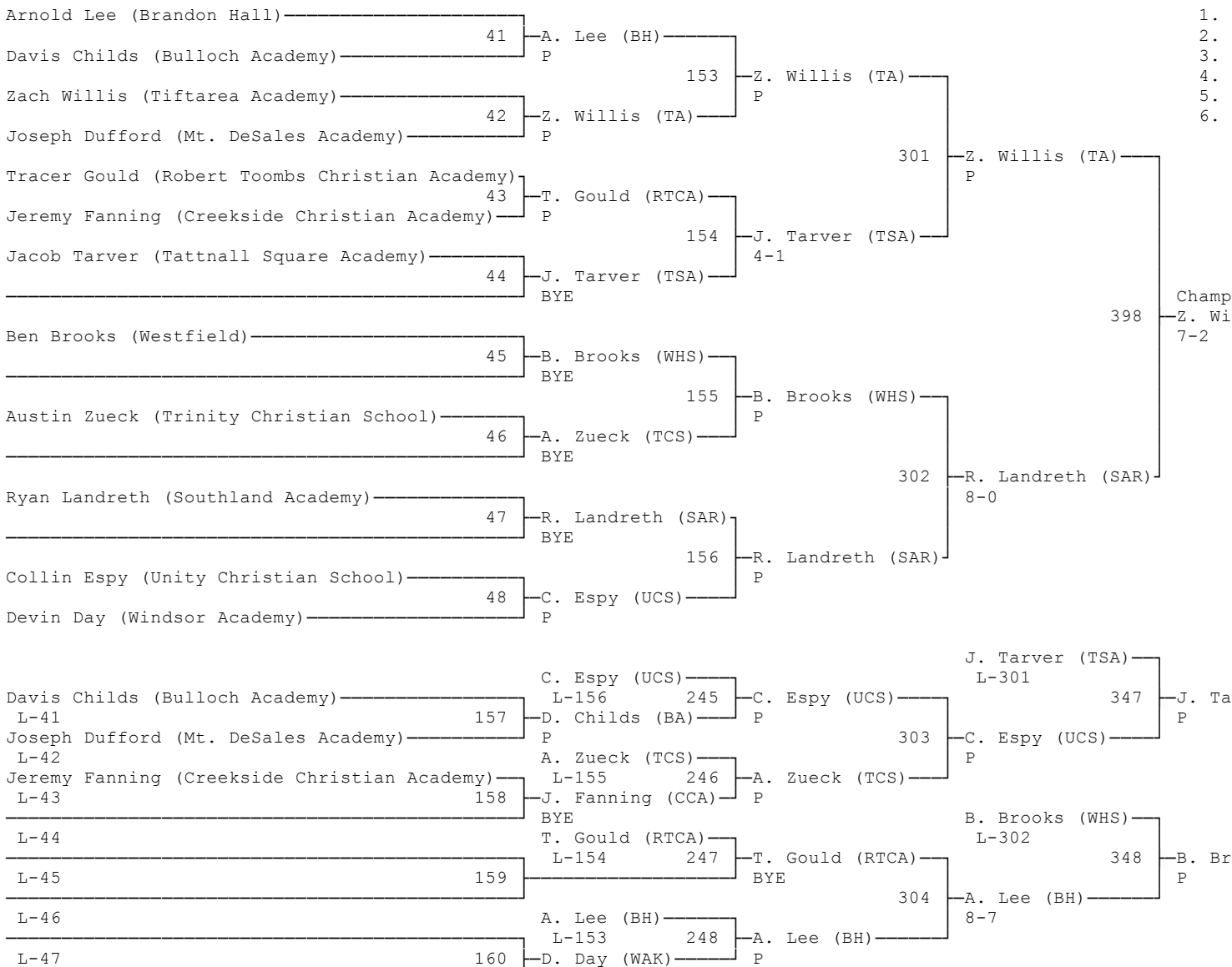

Devin Day (Windsor Academy) -----] BYE
L-48

C. Espy (UCS) -----] Fifth
L-347 375 -----] A. Lee (BH)
A. Lee (BH) -----] P
L-348

145 lbs (back to top)

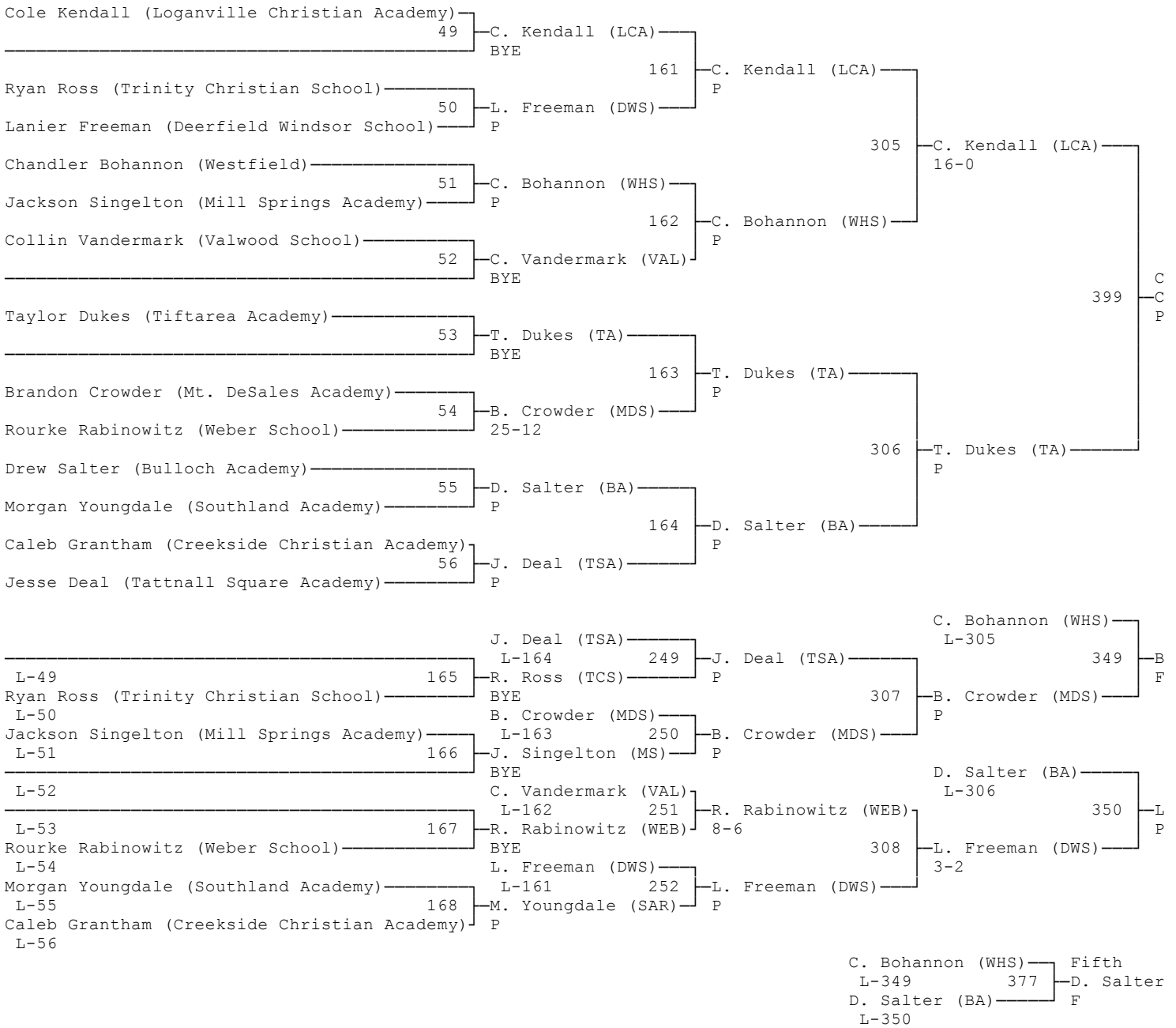

152 lbs (back to top)

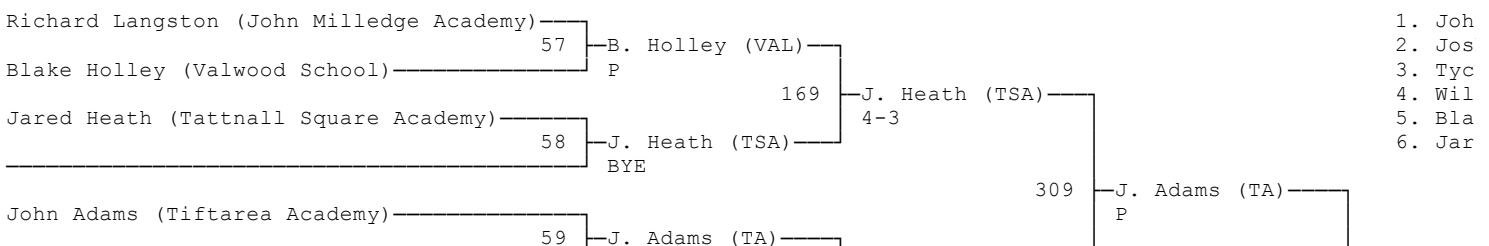

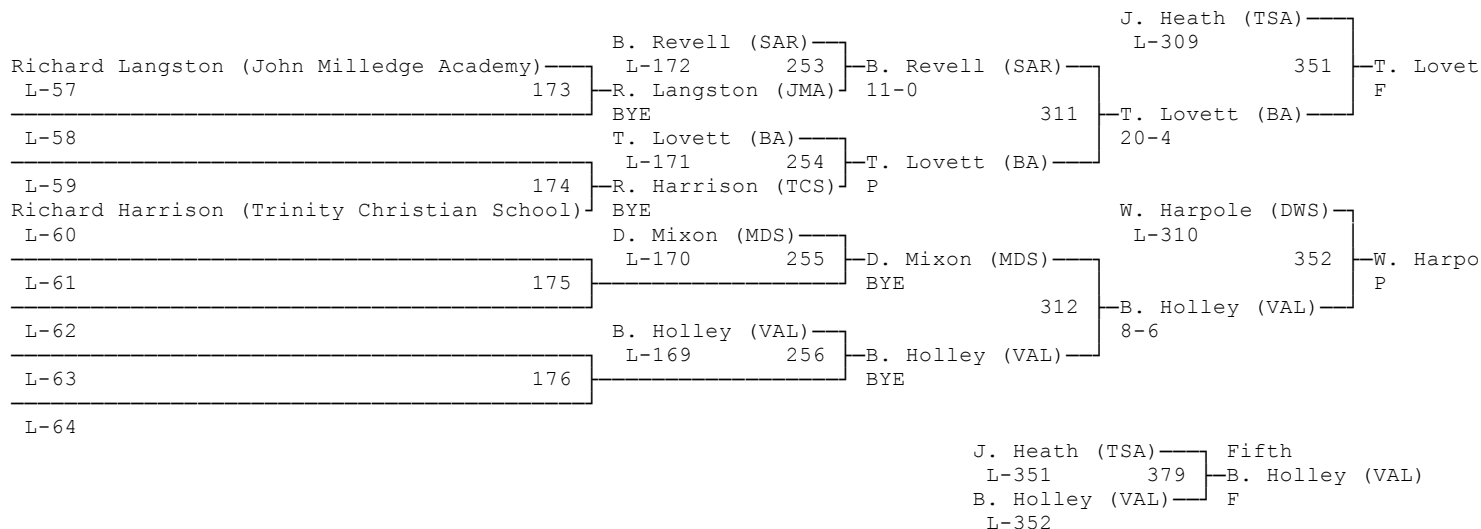
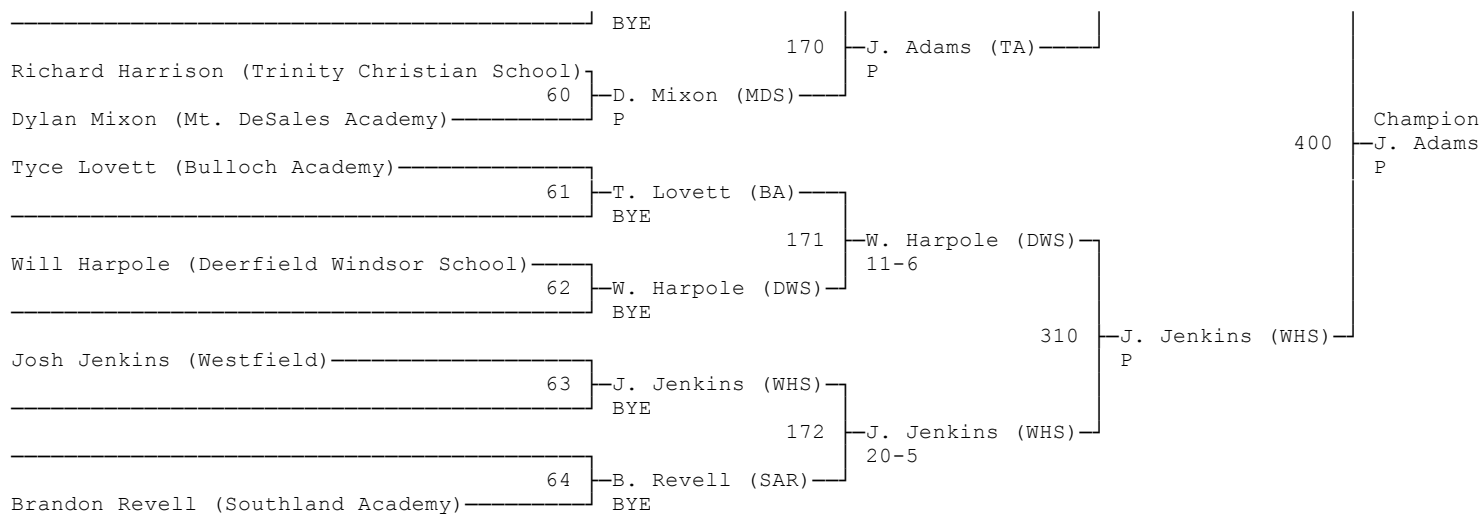

160 lbs (back to top)

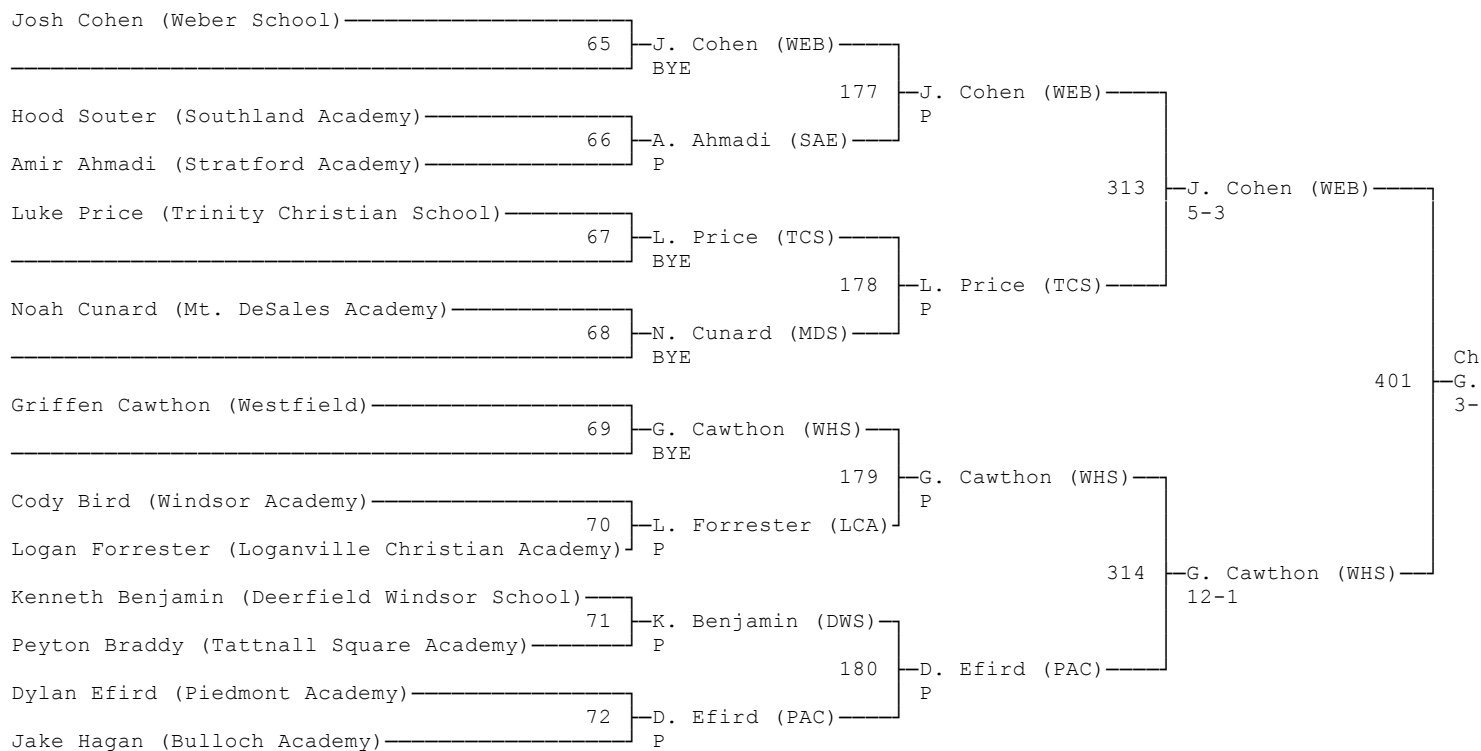

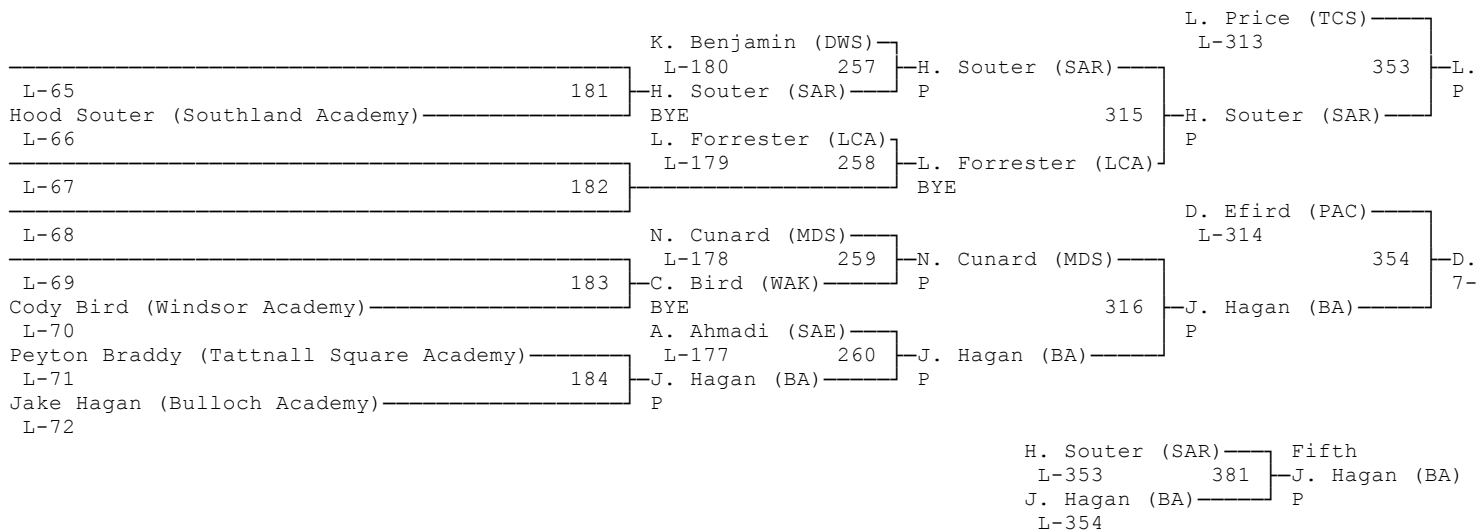

170 lbs [\(back to top\)](#)

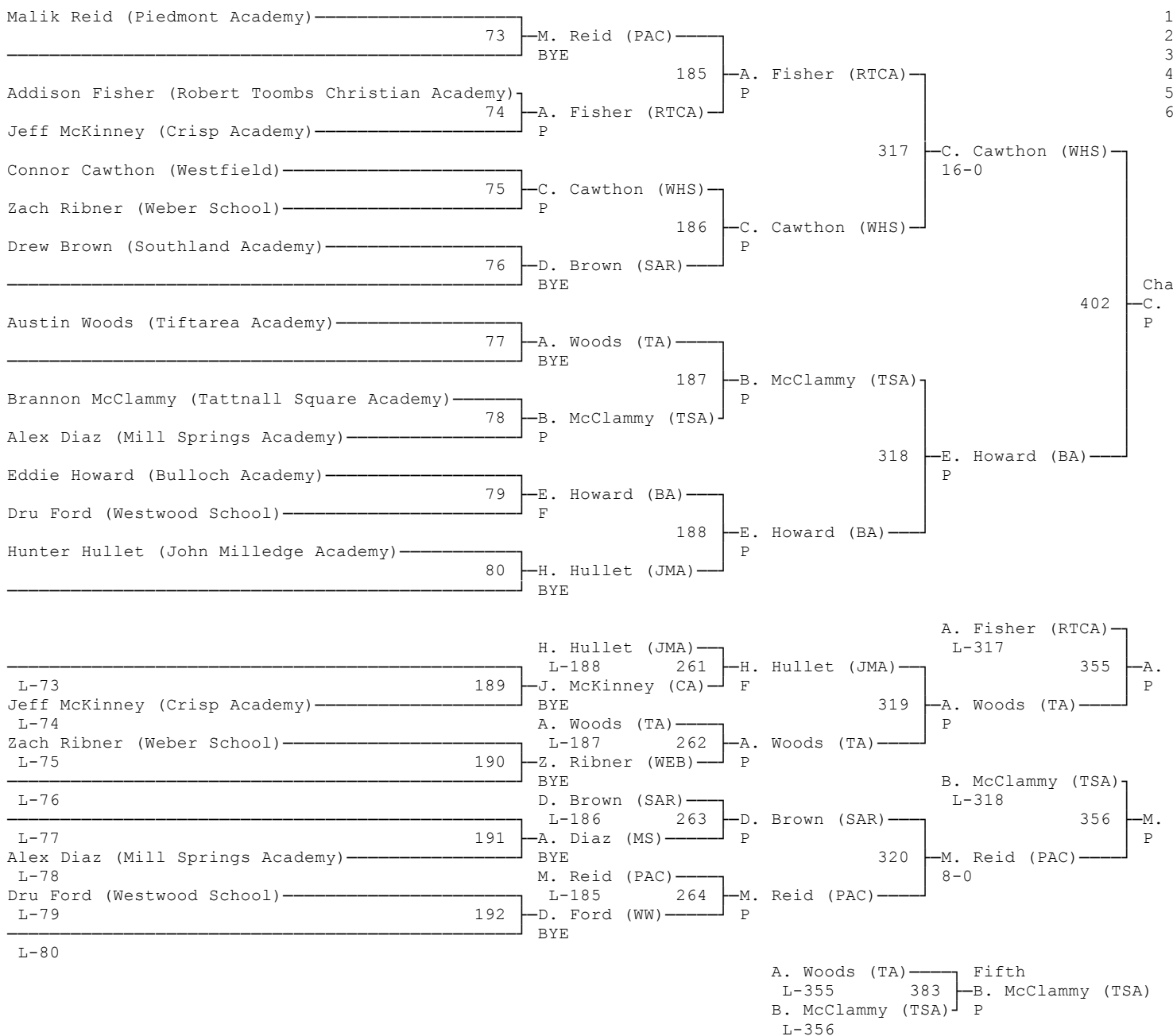

182 lbs (back to top)

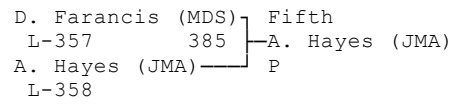
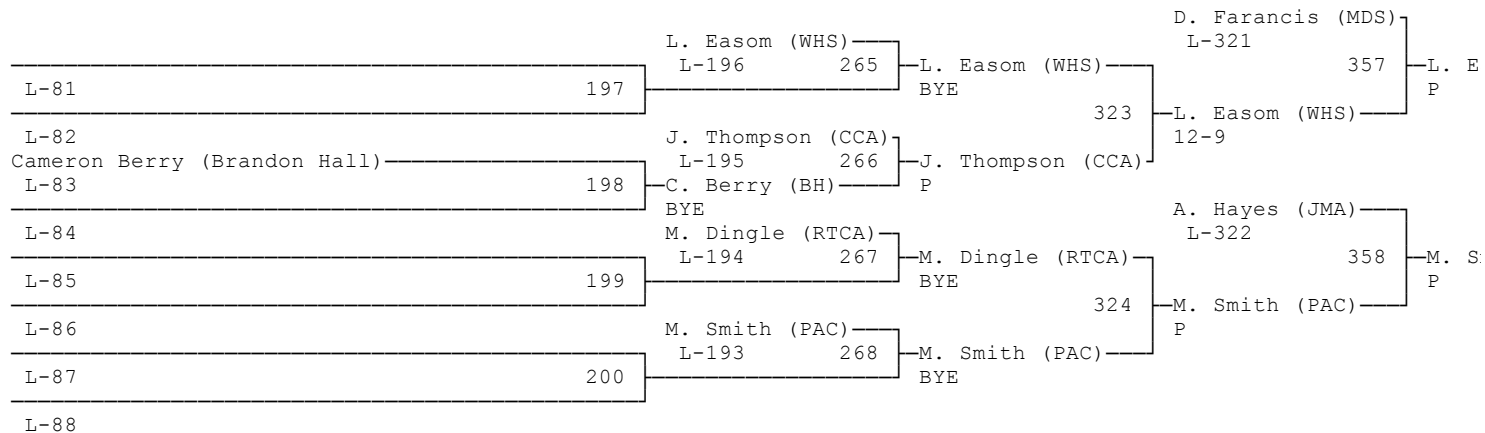
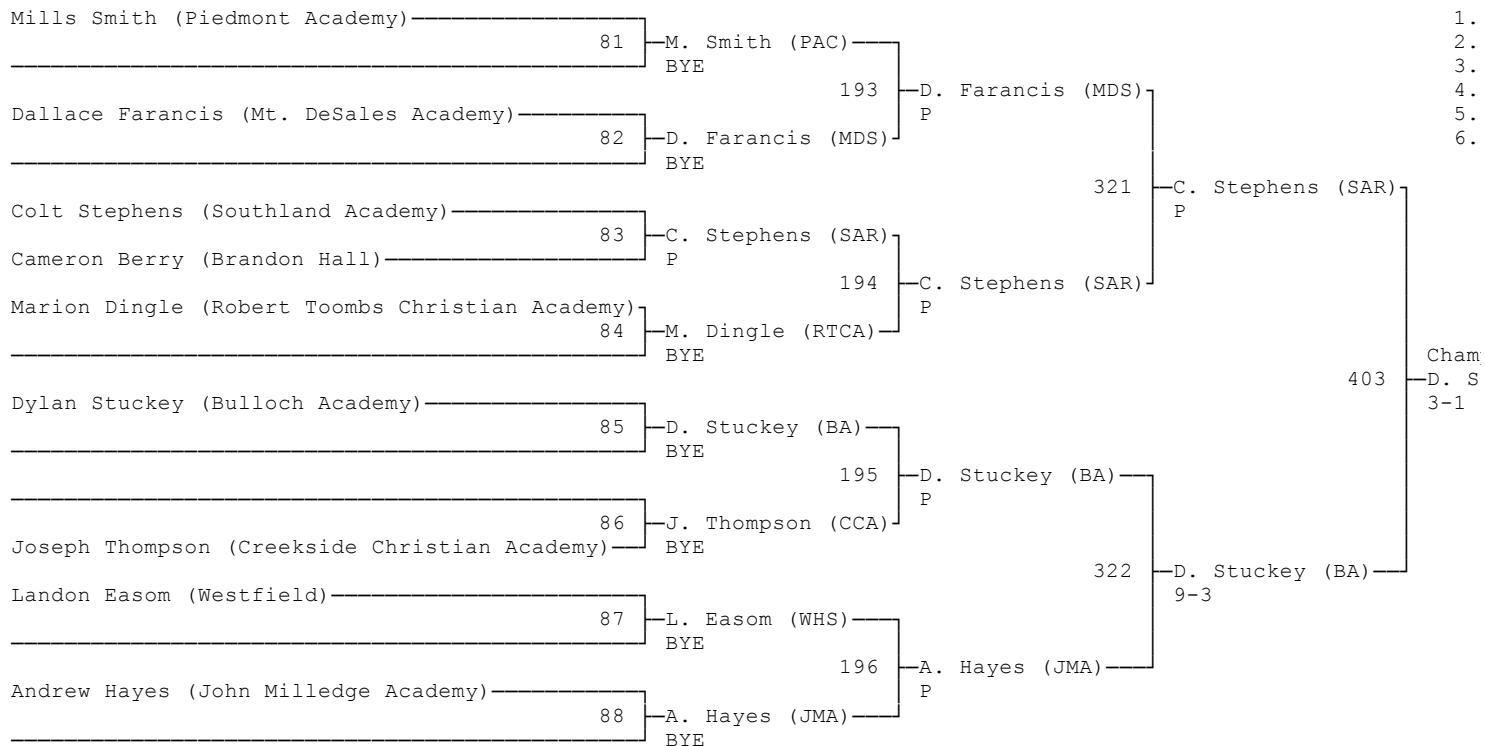

195 lbs (back to top)

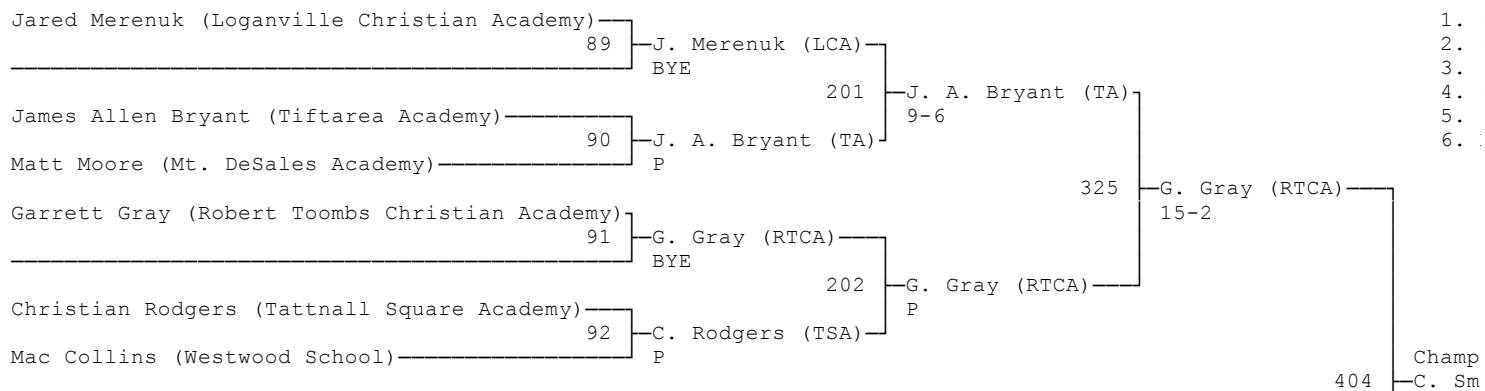

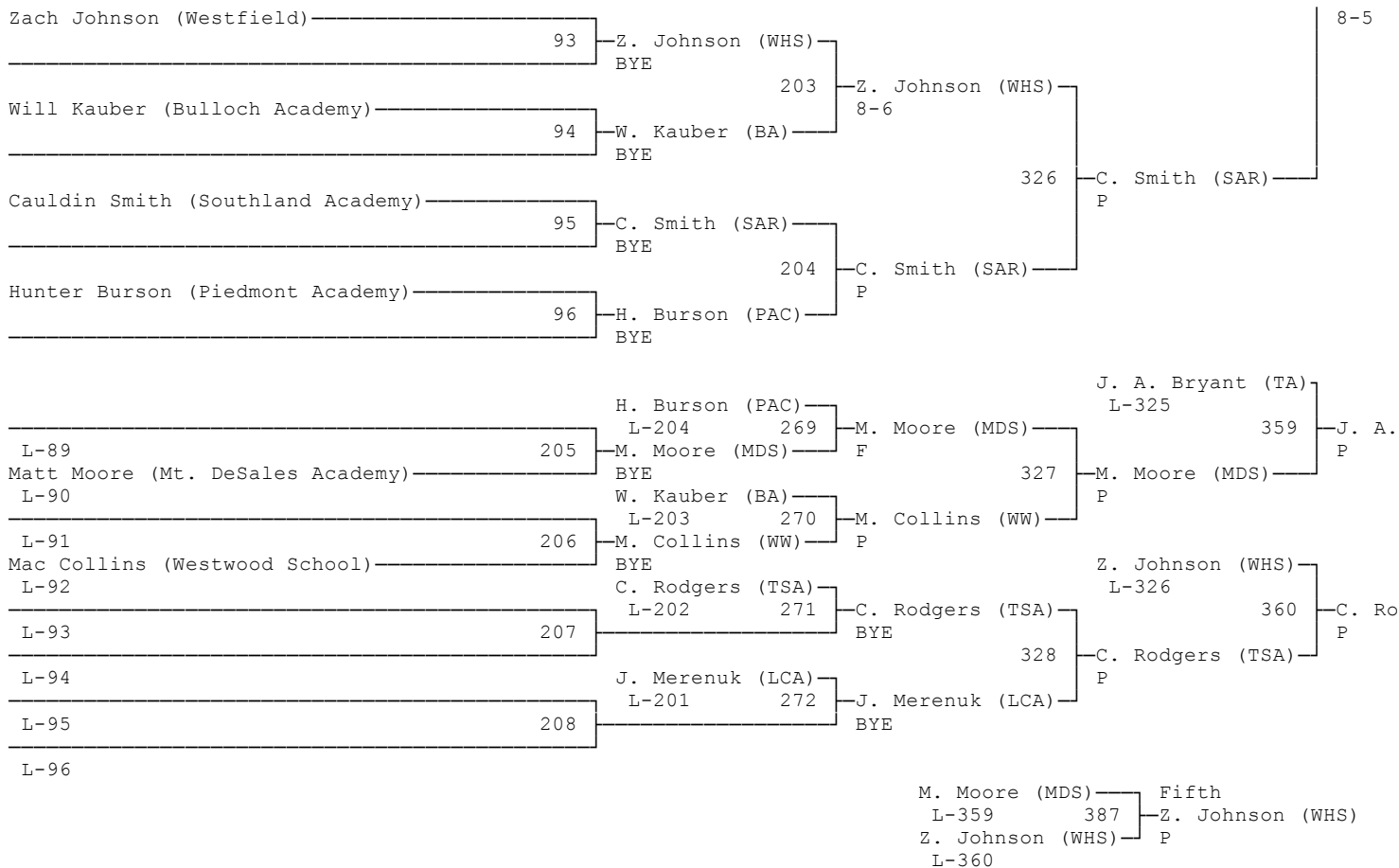

220 lbs (back to top)

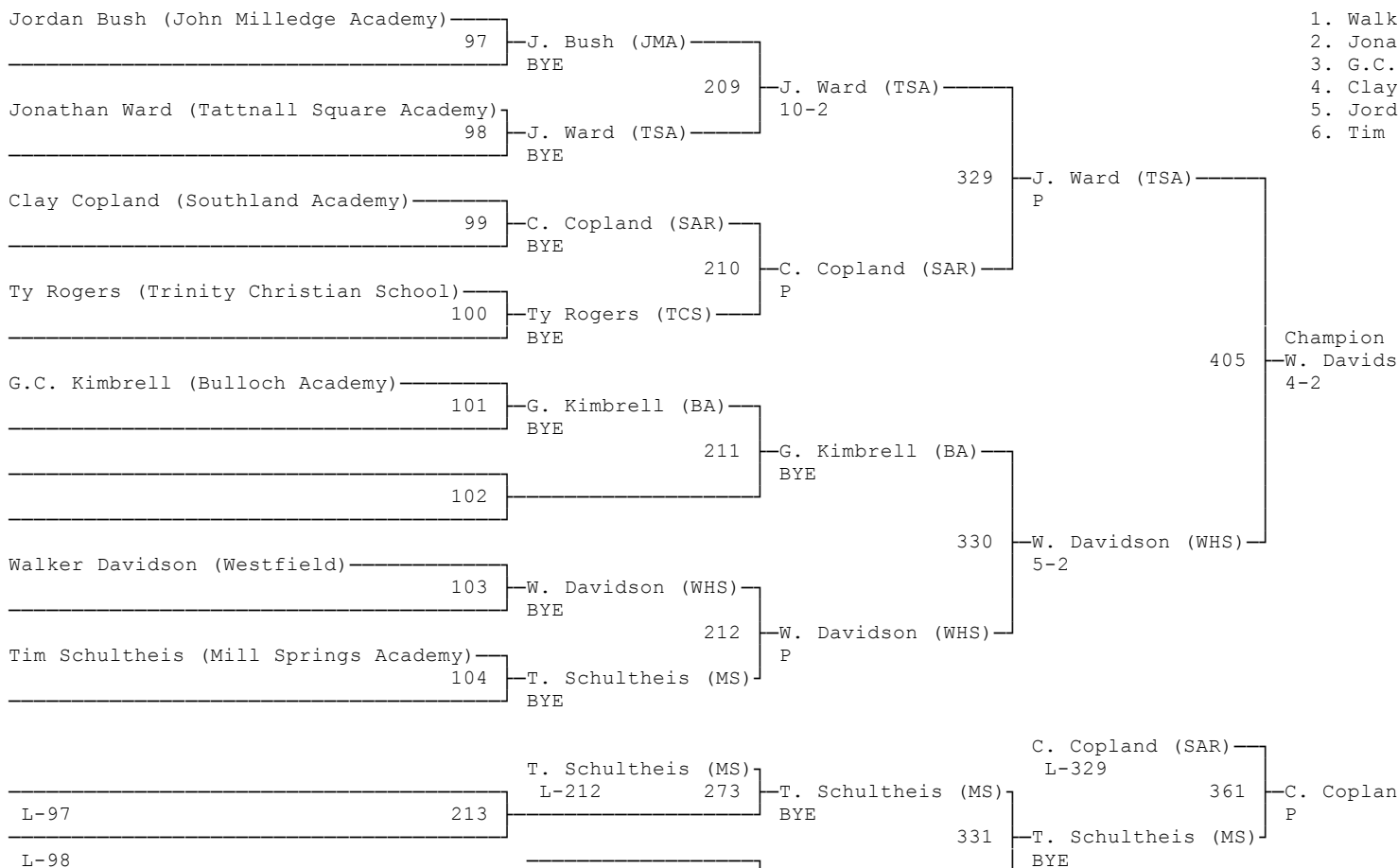



2014 GISA State Dual Wrestling Tournament

Bulloch Academy hosted the 2014 GISA State Wrestling Duals Championships in Statesboro on Saturday, January 18, 2014.

This event included the Top 8 talents in GISA Wrestling. Teams were required to qualify out of the 4 Regions in GISA.

Preview of Teams that were featured:

Bulloch Academy, Statesboro
2013 State Runners-Up, 2012 State Champions, 2011 State Runners-Up

Robert Toombs Christian Academy, Lyons
Top 10 Team since '09

Southland Academy, Americus
2002 State Champions

Trinity Christian School, Dublin
2011 GISA State Champions

Valwood School, Hahira
Top 5 Team since '08

Mount de Sales Academy, Macon
State contender every year

Tattnall Square Academy, Macon
State contender every year

Mill Springs Academy, Alpharetta

What is the difference in a Traditional Tournament and a 'DUALS' Tournament?

A Traditional Tournament is kind of like a Track meet, where competitors compete in their own individual events, and score points if they place. Those points are tallied up at the end of the meet, and a Team Champion is crowned by which team accumulated the most points. A Traditional Tournament is the same.

A 'DUALS' Tournament is where two teams, competing as full 14-man teams, compete against another full team at one time. With 14 weight classes represented from each team in these weight categories:

106, 113, 120, 126, 132, 138, 145, 152, 160, 170, 182, 195, 220, and 285

During each of the 14 different bouts, wrestlers score points for the overall **Team Score** which is kept throughout the duration of the 'dual'. Wrestlers can win by pin (6 points); by forfeit (6 points); by technical fall (5 points); by major decision (4 points); or by minor decision (3 points).

RESULTS:

ROUND 1

VALWOOD DEFEATED BY **TRINITY CHRISTIAN**: 38-32

ROUND 2:

BULLOCH DEFEATS MILL SPRINGS: 84-0

TATTNALL DEFEATS TRINITY CHRISTIAN: 55-18

SOUTHLAND DEFEATS MOUNT DE SALES: 64-14

ROBERT TOOMBS DEFEATS JOHN MILLEDGE: 58-12

ROUND 3:

BULLOCH DEFEATS SOUTHLAND: 54-27

ROBERT TOOMBS DEFEATS TATTNALL: 62-18

ROUND 4:

CHAMPIONSHIP MATCH: **BULLOCH** DEFEATS ROBERT TOOMBS: 58-14

3RD PLACE MATCH: **SOUTHLAND** DEFEATS TATTNALL SQUARE: 55-12

1st Place: Bulloch Academy

2nd Place: Robert Toombs Christian Academy

3rd Place: Southland Academy

4th Place: Tattnell Square Academy